

FLEXURAL CAPACITIES AND STRESS BLOCK PARAMETERS FOR HIGH-STRENGTH CONCRETE COLUMN

KAPASITAS LENTUR DAN PARAMETER BLOK TEGANGAN PADA KOLOM BETON MUTU TINGGI

Antonius¹⁾

¹⁾Department of Civil Engineering, Universitas Islam Sultan Agung (UNISSULA), Semarang, e-mail: antoni67a@yahoo.com

ABSTRACT

Flexural behaviour of reinforced high-strength concrete columns is studied in this paper. Tests of 12 high-strength reinforced concrete columns under eccentric loading were conducted, with test parameters included the concrete strength, longitudinal reinforcement ratio, load eccentricities and lateral reinforcement characteristics i.e: spacing and volumetric ratio. Concrete strength used were around of 50 and 70 MPa. From this study, the main result shows that curvature ductility increase with increasing volumetric ratio or reduction of tie spacing for lateral reinforcement. Comparison between stress block parameter models developed by many researchers with the test results was evaluated. It is found that the model adopted in the Indonesian National Standard (SNI 03-2847-2002) and ACI need to be modified before they can be utilized in the flexural design of structures made of high-strength concrete.

Key words: high-strength concrete, flexure, stress block parameter, interaction diagram

ABSTRAK

Paper ini menyajikan suatu studi mengenai perilaku lentur pada kolom beton bertulang mutu tinggi. Pengujian dilakukan terhadap 12 buah kolom beton bertulang mutu tinggi yang dibebani secara eksentrik, dengan meninjau beberapa parameter yaitu kuat tekan beton, rasio tulangan longitudinal, eksentrisitas beban dan karakteristik tulangan lateral seperti spasi dan rasio volumetrik. Kuat tekan beton yang digunakan berada di kisaran 50 dan 70 MPa. Dari hasil studi ini, hasil utama menunjukkan bahwa daktilitas kurvatur spesimen akan meningkat dengan peningkatan rasio volumetrik atau reduksi spasi tulangan lateral. Perbandingan antara model-model parameter blok tegangan yang telah dikembangkan oleh para peneliti dengan hasil pengujian juga dievaluasi dalam studi ini. Berdasarkan hasil evaluasi ditemukan bahwa model blok tegangan yang diadopsi di dalam Standar Beton Indonesia (SNI 03-2847-2002) dan ACI perlu dimodifikasi terlebih dahulu sebelum diaplikasikan dalam desain lentur untuk struktur yang terbuat dari beton mutu tinggi.

Kata-kata kunci: beton mutu tinggi, lentur, parameter blok tegangan, diagram interaksi

INTRODUCTION

Until the last decade, high-strength concrete (HSC) material is more popular because the main mechanical properties, i.e. high performance, capacity, durability and other properties. One of the advantageous characteristics of high strength concrete enables the use of reinforced concrete columns with smaller cross sectional dimensions for high-rise buildings and longer the bridge span for pre-stress concrete beam. Several design equation of high-strength concrete have published and proposed for the design application of structural members; i.e: Ibrahim & Mac Gregor (1997), CEB-FIP (2008), Mertol et al. (2008).

It is convenient, to define an arbitrary lower limit for the definition of high-strength concrete. Based on summary of many investigations of HSC and current design practices and equations in Indonesian National Standard for reinforced concrete design (SNI 03-2847-2002) and ACI 2005, in this paper the limit of 50 MPa is used to define the lower limit of high-strength concrete.

HSC material tends to substantial questions concerning not only the bearing capacity, but also its ductility and post-peak behavior. High-strength concrete members usually suffer from lower ductility and exhibit premature spalling of concrete cover under high compression [Bae & Bayrak, 2003 and Antonius, 2004]. Deformability of reinforced concrete columns under earthquake loadings is the essential and significant influence the stability of structures. A better understanding of high-strength concrete behavior in reinforced concrete

structures such as columns is needed, also verified available models are required.

It is well known that concrete confined by lateral reinforcement indicated increased strength and ductility. Many researchers have put a relatively large amount of effort into understanding the confinement mechanism and introducing a suitable model for the behavior of confined concrete in reinforced concrete elements subjected concentric and eccentric loadings. Antonius (2011) showed that design variables such as the confining reinforcement characteristics are the important factor that influence the strength and ductility confined concrete columns under eccentric loadings. Moment-curvature relationships obtained based on confinement model developed for concentric compression produced good correlations with envelopes of experimentally obtained moment-curvature hysteretic relationships.

Consequence in the design of reinforced concrete members with flexure is rectangular compression stress block in the current code provisions need to be evaluated. The design equations of stress block parameters in the SNI and ACI code are limited for concrete strength up to 55 MPa. Therefore, it is need to investigate the accuracy of the equations for the design of structural members constructed of higher strength concrete.

This paper presents the evaluation of flexural capacity of high-strength concrete columns based on experimental results. Flexural capacity and curvature ductility also discussed to understand the influence of several variables of confinement, i.e. volumetric ratio, spacing, longitudinal reinforcement number in the specimens. Stress block parameters models also explain and compared with test results in the shape of interaction diagrams of axial capacity and moment.

EXPERIMENTAL TEST

Twelve high-strength concrete columns were produced with the design parameters of concrete strength, characteristics of lateral reinforcement, number of longitudinal reinforcement and ratio of end eccentricity to the length of columns cross section.

Materials

Two different mixes were used to set cylindrical strength target of high-strength concrete (50 and 70 MPa). The sand and coarse aggregate used were taken from a local pit. The maximum size of coarse aggregate used is 14 mm. The super-plasticizer (SP) with brand name of Sikament NN was used to improve the workability of the high-strength concrete mix. Fly Ash with fifteen percent by weight of the Portland cement was substituted in the mix design.

The lateral reinforcement used was plain rebar with 5.5 mm diameter, with the yield stress of 315 MPa, and longitudinal reinforcement was deformed bars with 10 mm diameter with the yield stress of 340 MPa. Yield stress of reinforcement was determined by tension tests and the stress-strain curves shown in Figure 1.

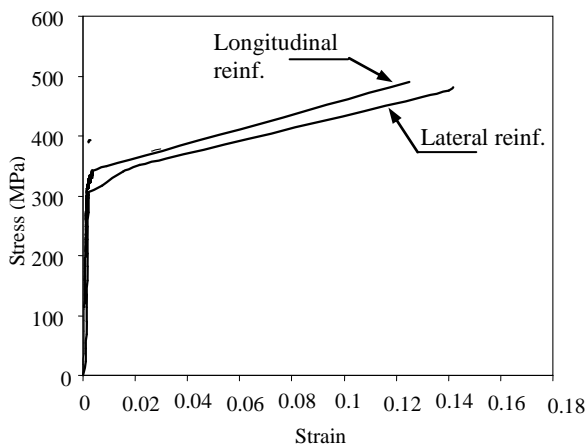

Figure 1. Stress-strain curves of lateral and longitudinal reinforcement

Specimen Details and Instrumentation

In this research, twelve columns had a square sections 120x120 mm and height 700 mm were produced. Two of these did not have reinforcement in the test region as the control specimens. Figure 2 shows the column cross-section and instrumentation. Concrete cover of nominally 10 mm was used in the specimens. Test region was 350 mm length in the middle height of columns. Strain gauges with FLA-5 type were used to monitor strains in reinforcements, and displacement transducers (LVDT) were used to measure axial and lateral deformations in tested columns.

All instrumentations were connected to the computer based on data acquisition system. All columns were tested under monotonically increasing axial compression with constant end eccentricity in Universal Testing Machine (UTM) with 1000 kN capacity. The tests were done under displacement control. The load was given in regular increment, and sets of deformation readings were taken in every load stage. The measured experimental variables were axial force, longitudinal and lateral deflections of specimens, strain of reinforcement. The type and character of the failure was also observed.

Flexural Strength and Ductility Analysis

The flexural strength measured by multiply load of column with the eccentricity. The bending capacity can be calculated with reasonable accuracy using the rectangular stress block parameters defined by codes (SNI and ACI). Confined concrete area in this study is measured from center to center of perimeter steel. Curvature ductility ratio (μ_ϕ) was determined as the ratio of curvature of confined concrete at 85 percent of the maximum moment on the descending branch to curvature of unconfined concrete corresponding to the maximum moment.

TEST RESULTS AND DISCUSSION

Loads, moments and curvature ductility from tests results are listed in Table 1. The specimen control (CC1 and CC2) failed suddenly in an explosive manner. Figure 3 shows examples of failure of columns with concrete strength of 51.7 MPa and 72 MPa. The specimens failed by crushing in the most compressed fibers near the compression face. The figures also describe that for higher strength concrete, failure of the specimen signed by crushing at the compression zone is more brittle.

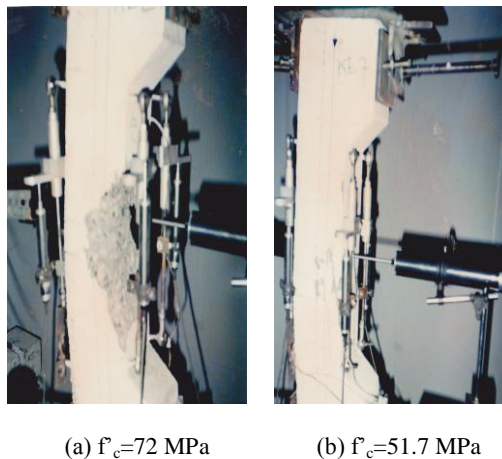

Figure 3. Failure of columns

In specimens with concrete strength 72 MPa showed smaller the flexural capacity than predicted based on analysis ($M_{max}/M_{SNI} < 1$). Otherwise, in lower strength concrete ($f'_c = 51.7$ MPa) the flexural capacity tends higher than prediction adopted in the codes, whereas the ratio of maximum moment based on experiments to the moment calculation is greater one. The implication of this phenomenon indicate unconservative prediction of the flexural equations used in the SNI and ACI codes for high-strength concrete columns.

Curvature ductility values as shown in Table 1 are influenced by confinement of lateral reinforcement installed. Design parameters of confinement also affect directly the curvature ductility.

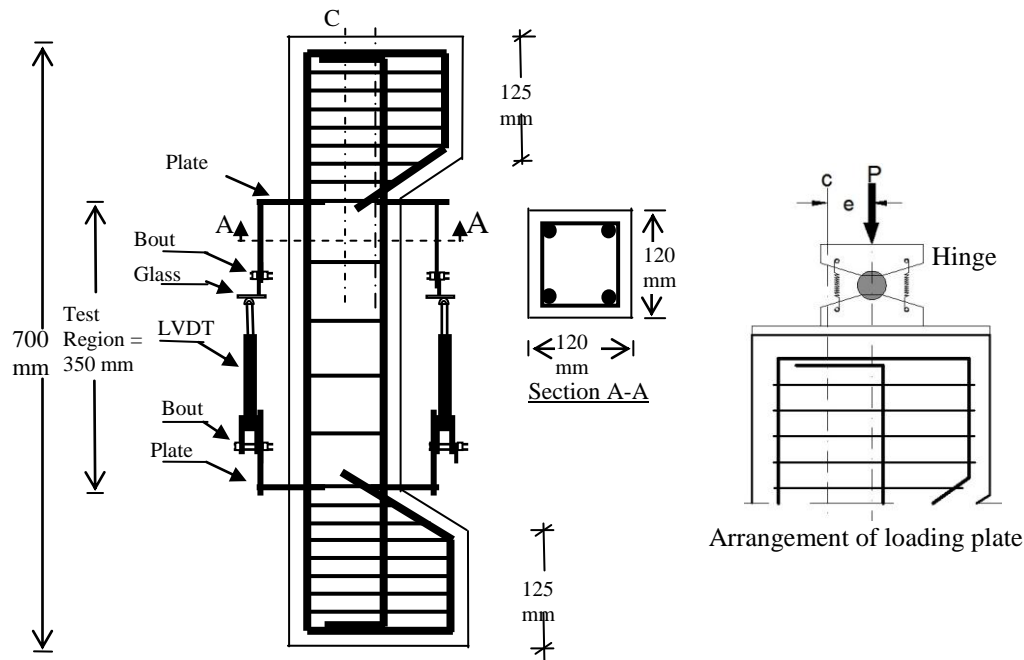

Figure 2. Detail of column specimens

Table 1. Properties of Specimens and Test results

Columns	f'_c (MPa)	e/h	Lateral reinf.		Longitudinal reinf. ρ (%)	$P_{max.}$ (kN)	$M_{max.}$ (kN-m)	$M_{max.}/M_{SNI}$	μ_ϕ
			Spacing (mm)	Ratio (ρ_h =%)					
CC1		-	-	-	-	726.8	-	-	-
C1		0	35	3.35		967	-	-	-
C2	72	0.21	35	3.35	2.18%	600.3	12.3	0.98	2.41
C3		0.42	35	3.35		418.5	15.2	0.96	2.2
C4		0.21	70	1.68		546.7	13.29	0.96	1.56
C5		0.42	35	3.35	3.27%	384.2	16.12	0.99	3.13
CC2		-	-	-	-	701.6	-	-	-
C6		0	35	3.35		833	-	-	-
C7	51,7	0.21	35	3.35	2.18%	585.7	8.05	1.1	2.2
C8		0.42	35	3.35		386	12.54	1.05	2.36
C9		0.21	70	1.68		570.9	7.86	1.08	2.05
C10		0.42	35	3.35	3.27%	353.7	13.8	1.1	4.3

Columns with greater than 3% volumetric ratio of lateral reinforcement and six laterally supported longitudinal reinforcements shows higher ductility value, others with four longitudinal reinforcement shows smaller ductility. Detail of the effect of these confinement for specimens under eccentric loadings has presented by author (2011).

STRESS BLOCK PARAMETERS

Rectangular stress block equations adopted in Indonesian Concrete Code (SNI) to estimate the flexural strength of high-strength concrete specimens and the results shown in Table 1 are unconservative predictions for column capacity. Hence, evaluation of models of stress block parameter is great significance.

Figure 4 draws the stress block parameters that could be obtained from tests, they are k_1 , k_2 and k_3 . Definition the rectangular stress block defines by the parameters α_1 and β_1 as shown in the Figure. The k_3 factor takes account of several factors that contribute to the differences between the in situ compressive strength of concrete and the strength determined from standard cylinders. The k_2 factor represents the stress block depth factor while the k_1 factor is the stress block width factor. The relationship between the parameters used in this paper and conventional terminology is that $k_1 k_3$ is equal to α and k_2 is equal to β_1 .

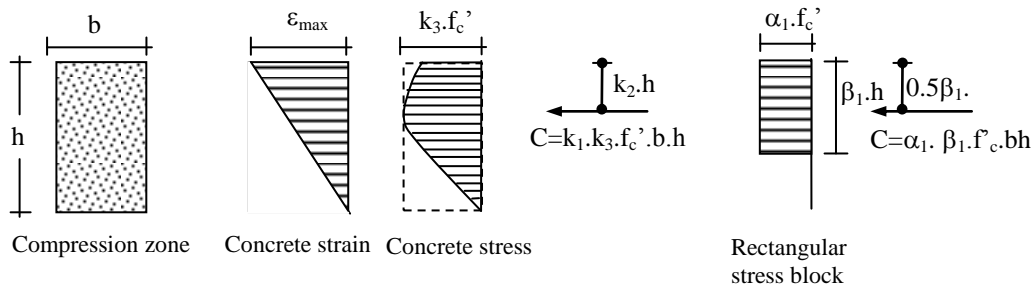

Figure 4. Stress block parameters

Table 2. Rectangular stress block models

Model	$k_1 k_3 (= \alpha_1)$	$k_2 (= \beta_1)$
SNI 2002/ACI	0.85	$1.09 - 0.008 f'_c$ $0.85 \geq k_2 \geq 0.65$
Attard & Steward (1998)	$1.29(f'_c)^{-0.1} \geq 0.71$	$1.095 (f'_c)^{-0.091}$ ≥ 0.67
NZS3101-1995	$1.07 - 0.004 f'_c$ $0.85 \geq k_1 k_3 \geq 0.75$	$1.09 - 0.008 f'_c$ $0.85 \geq k_2 \geq 0.65$
Ibrahim & MacGregor (1997)	$0.85 - f'_c / 800$ ≥ 0.725	$0.95 - f'_c / 400$ ≥ 0.70
Bae & Bayrak (2003)	$0.85 - 0.004(f'_c - 70)$ 0.85 for $f'_c \leq 69$ ksi	$0.85 - 0.004(f'_c - 30)$
Mertol et al. (2008)	$0.85 - 0.0029(f'_c - 69) \geq 0.75$ for $f'_c > 69$ ksi	0.85 for $f'_c \leq 28$ ksi $0.85 - 0.007252(f'_c - 28) \geq 0.65$ for $f'_c > 28$ ksi

Table 2 shows the rectangular stress block models adopted in codes and proposed by researchers. The code provisions by SNI, similar with ACI, α_1 is assumed to have a constant value of 0.85. The parameter β_1 is equal to 0.85 for concrete strengths up to 30 MPa and is reduced gradually at a rate of 0.08 for each 10 MPa of concrete strength in excess of 30 MPa to the limit that $\beta_1 \geq 0.65$. The ultimate compressive strain ϵ_{max} is taken to have a constant value of 0.003 for all concrete strengths. Similar equation of β_1 in New Zealand Standard (NZS3101-1995) but for α_1 value is differ.

Attard and Steward (1998) proposed a model relate to mean cylinder concrete strength and specified strength for use in the design formulas. Hence the equations of α_1 and β_1 were non-linear and tends decrease with the increasing of concrete strength. The model proposed by Ibrahim & Mac Gregor (1997) select a value of β_1 from test results of 20 high-strength column specimens. The parameter α_1 was derived to provide a conservative lower bound for the experimental data on k_3 . The model proposed by Bae & Bayrak (2003) based on main consideration that effect of early cover spalling of high-strength concrete column tests. The stress-strain curve recommended by Collins et al used to determine parameters of the stress block.

Mertol et al (2008) proposed the model based on collecting data and experimental program of 21 plain concrete in the test regions. They proposed for the generalized stress block parameters, and the lower bound relationships for rectangular stress block parameter α_1 is 0.75 and for β_1 is 0.65.

Furthermore, the models explained above were examined with the column test results through the interaction diagrams of axial load versus moment. Column specimens obtained as validation, they are C2, C3, C4 and C5 for specimens with concrete strength of 72 MPa and specimens of C7, C8, C9 and C10 for columns with concrete strength of 51.7 MPa. It can be seen from Figure 5 that for specimens with concrete strength 72 MPa, the SNI and ACI interaction dia-

grams overestimate for the capacity of axial and flexural capacities. All interaction diagrams for specimens with concrete strength of 51.7 MPa shows conservative in the capacities of axial load and moment (Figure 6).

CONCLUSIONS

Studies on the flexural behaviour of reinforced high-strength concrete columns is presented include the analysis, experimental program and examined the equation models to the test results. Lateral reinforcement characteristics and a number of longitudinal reinforcement have important role in determining the flexural capacities and ductility of high-strength concrete columns. The current SNI and ACI rectangular stress block parameters for design for high-strength concrete columns with concrete compressive strength of 72 MPa with flexure are overestimate in the prediction capacities. Hence it is need to modified stress block parameters in the current codes. Other alternative models proposed by researchers, such as models by NZS, Mertol, Ibrahim, Bae or Attard, could be utilized in designing for high-strength concrete columns.

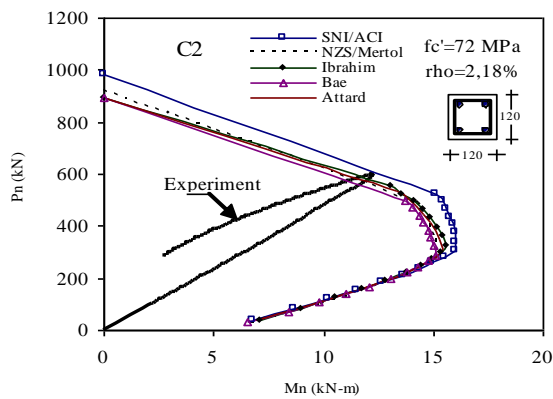

(a) Column C2; $\rho=2.18\%$, $e/h=0.21$

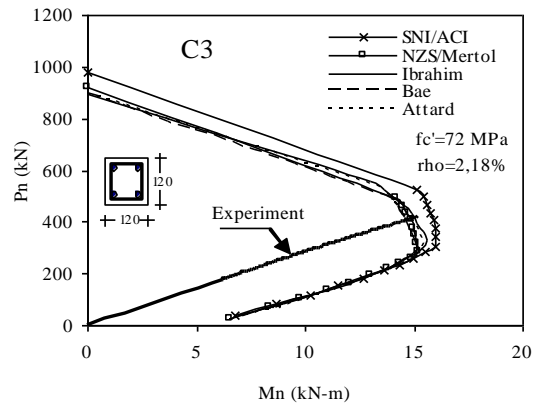

(b) Column C3; $\rho=2.18\%$, $e/h=0.42$

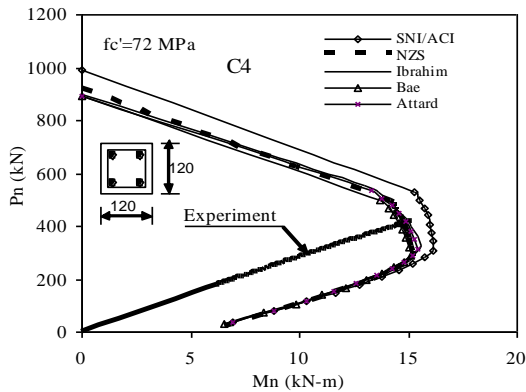

(c) Column C4; $\rho=2.18\%$, $e/h=0.21$

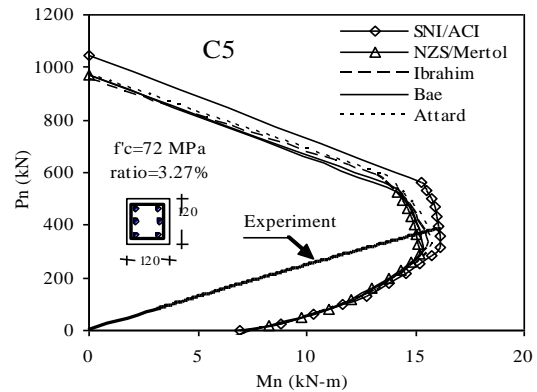

(d) Column C5; $\rho=3.27\%$, $e/h=0.42$

Figure 5. P-M Diagram of rectangular stress block models with experiments; $f'_c=72$ MPa

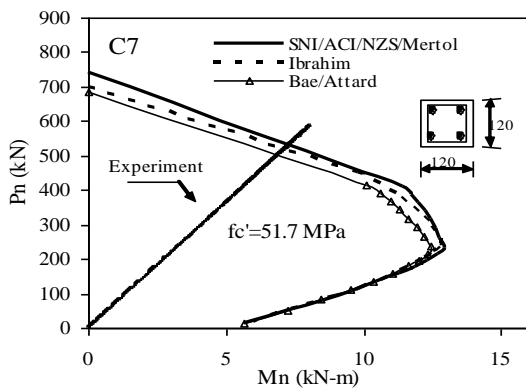

(a) Column C7; $\rho=2.18\%$, $e/h=0.21$

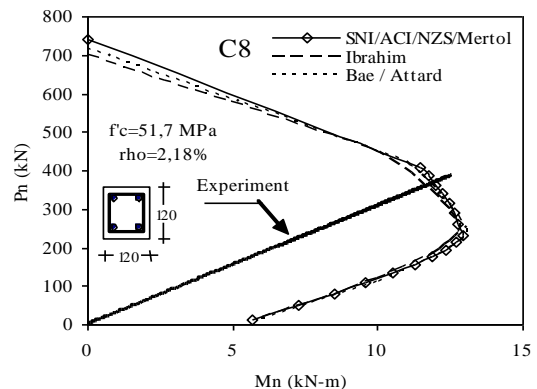

(b) Column C8; $\rho=2.18\%$, $e/h=0.42$

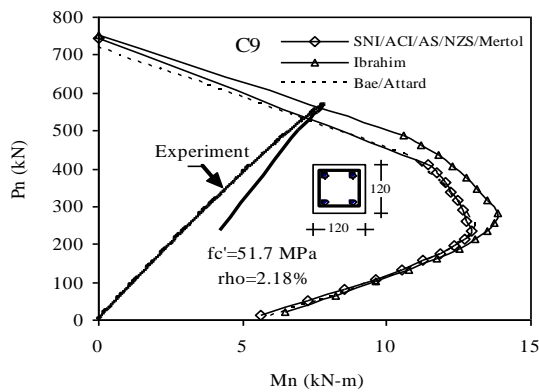

(c) Column C9; $\rho=2.18\%$, $e/h=0.21$

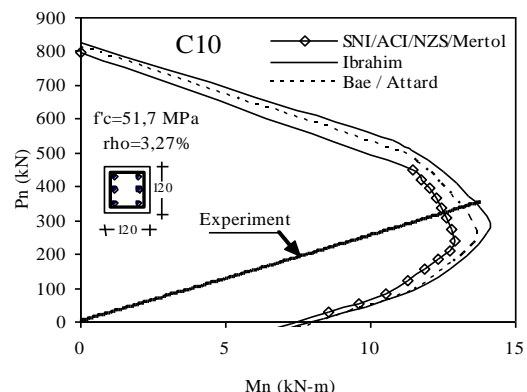

(d) Column C10; $\rho=3.27\%$, $e/h=0.42$

Figure 6. P-M Diagram of rectangular stress block models with experiments; $f'_c=51.7$ MPa

ACKNOWLEDGMENTS

Funding for this experimental program was provided by Directorate General of Higher Education, Ministry of National Education, Republic of Indonesia through the Competitive Research Program. The contributions received for this research are gratefully acknowledged.

NOTATIONS

α, β_1	=	stress block parameters
e	=	loading eccentricity
ϵ_c	=	strain of concrete
$\epsilon_{\max} = \epsilon_{cu}$	=	ultimate strain of concrete
ϵ_{85c}	=	strain of confined concrete at 85% of confined concrete peak stress
f	=	stress of concrete
f'_c	=	concrete compressive strength of cylinder 150x300 mm at 28 days
k_1, k_2, k_3	=	stress block parameters
M_{\max}	=	maximum moment of column under flexure
ϕ	=	curvature
μ_ϕ	=	curvature ductility
ρ_h	=	ratio of lateral reinforcement
ρ	=	ratio of longitudinal reinforcement

REFERENCES

ACI Committee 318 (2005), "Building code requirements for structural concrete (ACI 318-05) and commentary (318R-05)", American Concrete Institute, Farmington Hills, MI, pp.430.

Antonius (2011), "Confinement effects on high-strength concrete columns subjected eccentric loading",

Proceeding of The 4th ASEAN Civil Engineering Conference, Yogyakarta, Indonesia, 22-23 Nov., pp.21-26.

Antonius (2004), "The influence of lateral reinforcement to the cover spalling mechanisms of high strength concrete column structures", *Proc. of National Conference of Earthquake Eng. II*, Gajah Mada Univ., Indonesia, pp.168-176, (in Indonesian).

Attard, M.M. and M.G. Steward (1998), "A two parameter stress block for high-strength concrete", *ACI Structural Journal*, V.95 (3), pp.305-317.

Bae, S. and O. Bayrak (2003), "Stress block parameters for high-strength concrete members", *ACI Structural Journal*, V.100 (5), pp. 626-636.

CEB-FIP (2008), *Constitutive Modelling of High Strength/High Performance Concrete; State of the Art Report*, January.

Foster, S.J. and M.M. Attard (1997), "Experimental tests on eccentrically loaded high-strength concrete columns", *ACI Structural Journal*, V.94 (3), pp.295-303.

Indonesian National Standard (2002), *Computational Method of Reinforced Concrete Structures for Building*, SNI-03-2847-2002 (in Indonesian).

Ibrahim, H.H.H. and J.G. MacGregor (1997), "Modification of the ACI rectangular stress block for high-strength concrete". *ACI Structural Journal*, V.94 (1), pp.40-48.

Mertol, H.C., S. Rizkalla, P. Zia, and A. Mirmiran (2008), "Characteristics of compressive stress distribution in high-strength concrete", *ACI Structural Journal*, V.105 (5), pp.626-633.

Steward, M.G. and M.M. Attard (1999), "Reliability and model accuracy for high-strength concrete column design", *Journal of. Struct. Eng. ASCE*, V.125 (3), pp. 290-300.

Teng-Hooi, Tan and Ngoo-Ba Nguyen (2005), "Flexural behavior of confined high-strength concrete columns", *ACI Structural Journal*, V.102 (2), pp.198-205.